



**INTERSTATE
SAFETY**

PRODUCT CATALOG 2026

TABLE OF CONTENT

| Description | Page # |
|--|---------------|
| Ear Plugs | 3 - 5 |
| Safety Glasses | 6 |
| Particulate Respirators | 7 - 10 |
| Disposable Face Masks | 11 |
| Hard Hats (Full Brim & Front Brim) | 12 |
| Sweatband / Ratchet Suspension / Earmuff / Chin Straps | 13 |
| Neck Shield / Safety Face Shield | 14 |
| Back Support Safety Belts | 15 - 16 |
| Disposable Safety Gloves | 17 - 18 |
| Rain Coat | 19 |

EAR PROTECTION - DISPOSABLE EARPLUGS

Ultra-Soft Foam Earplugs, Packaged in a Convenient Dispenser Box - 200 Pair Per Box

Orange



40201

Yellow



40202

Green



40203

Blue



40204



40205 Four Assorted Colors
(Orange, Yellow, Green, Blue)

32dB Highest Noise Reduction Rate

Features:

- Made with super low-pressure, slow release, Comfort Foam.
- With a Noise Reduction Rating (NRR) of 32 decibels, these versatile, noise blocking earplugs are great for studying, work, travel, concerts, relaxation, motorcycling, loud events, etc.

HOW TO USE

STEP 1



ROLL

Clean your hands then start rolling gently one earplug between your thumb and fingers to avoid crumples. Then firmly roll to make it as small & stiff as possible. Move quickly to step 2 before the foam expands.

STEP 2



PULL

With your other hand pull the top of your ear up and back to open your ear canal.

STEP 3



INSERT

While pulling your ear insert the rounded tip first and far enough. This can feel sensitive and it is normal.

STEP 4



HOLD

With forefinger hold earplug in place for about 30 seconds for the ultra soft foam to expand and form a snug fit.

CORRECT FIT:



The flat side of the earplug should be flush with the opening of your ear canal and not visible when you look at yourself in the mirror.

WRONG FIT:



The flat side of the earplug extends beyond the opening of your ear canal and is visible when you look at yourself in the mirror.

EAR PROTECTION - REUSABLE CORDED SILICONE EARPLUGS



32dB Highest Noise Reduction Rate

40206 - 2 Pcs / Plastic Case

40206BX - 200 Pairs Per Box

Reusable Silicone Waterproof Corded Ear Plugs

Features:

- Protect your hearing 32 (noise reduction level), use these versatile, noise blocking earplugs to avoid hurting your ears
- Health and environmental protection: Made of soft silicone material, the design is super comfortable and can adjust your ears. These reusable earplugs are comfortable even when worn for a long time They are water resistant and can be cleaned and reused.
- Simple structure: Each pair of earbuds comes with a waterproof nylon tether to prevent loss and reduce the time you spend looking for earplugs. Equipped with a mini plastic case, it can be conveniently stored and carried around.

HOW TO USE



While holding the stem, reach the opposite hand over your head & gently pull top of your ear up & back



Insert the ear plugs so all flanges are well inside your canal



Adjust for best noise reduction



Improper fittings will reduce effectiveness

EAR PROTECTION - REUSABLE SILICONE EARPLUGS



32dB Highest Noise Reduction Rate

40207 - 2 Pcs / Plastic Case

40207BX - 200 Pairs Per Box

Reusable Silicone Waterproof Ear Plugs

Features:

- The ear plugs come with a case that you can carry it around with you wherever you go. The practical storage case is going to keep your earplugs clean and within easy reach.
- Perfect shape fits most normal ear sizes of women and men. Ear plugs length is designed for different depth of ear canal.
- Made with hypoallergenic, medical grade silicone, these ear plugs are soft and nontoxic, so they are comfortable and safe to use, washable and reusable.

HOW TO USE



While holding the stem, reach the opposite hand over your head & gently pull top of your ear up & back

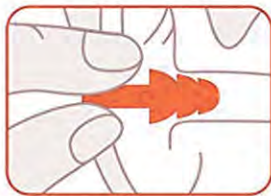

Insert the ear plugs so all flanges are well inside your canal



Adjust for best noise reduction



Improper fittings will reduce effectiveness

POLYCARBONATE IMPACT RESISTANT SAFETY GLASSES



ANSI Z87.1-2015



40251 - Clear Frame & Lens (Single Pair)

40251-12BX - Clear Frame & Lens (12/Box Packaging)

40252 - Smoke Frame & Lens (Single Pair)

40252-12BX - Smoke Frame & Lens (12/Box Packaging)

Features:

- Frameless, anti scratch lenses for optimum vision
- Lightweight frame, weighs less than 1 oz
- Polycarbonate lens exceeds ANSI Z87.1 standards, coated for scratch resistance and UV protection
- Contoured, flexible, Non-Slip temples for comfortable fit

Easy Cleaning and Maintenance:

Clean using lens cleaning towelettes or use a dry, or damp microfiber cloth to avoid potential loss of the anti-scratch features.

DISPOSABLE PARTICULATE RESPIRATORS



40351

N95 Disposable Dust Masks NIOSH-Certified Particulate Respirator - (20-Pack)

Features:

- NIOSH approved for at least 95 percent filtration efficiency against certain non-oil based particles
- Two-strap design with welded dual point attachment helps provide a secure seal
- Cushioning nose foam
- Lightweight construction promotes greater worker acceptance and may help increase wear time
- This N95 dust mask can be used for woodworking or painting at home or by professional carpenters, contractors, or lawn care specialists.
- Special filter material is designed for ease of breathing
- Protects respiratory system while grinding, sanding, or bagging
- Not recommended for asbestos or sandblasting protection

Note: Breathing hazardous particles can pose a risk to your health. NIOSH, a Federal government regulatory agency, has tested and approved the INTERSTATE SAFETY Particulate Respirator, which is designed to help reduce exposure to certain airborne particles.

All-IN-ONE Filtration System for Common Harmful Particle



Haze



Woodworking



Construction



Fire Smoke



Cutting



Mowing

DISPOSABLE PARTICULATE RESPIRATORS



40352

N95 Disposable Dust Masks with Exhalation Valve, NIOSH-Certified Particulate Respirator - (15-Pack)

Features:

- Valve easily opens during exhalation
- Disposable cup masks help protect your lung from small particulates like saw dust, metal shavings, pollen, allergens and more
- Meets all the filtering and breathing resistance requirements for N95 certification from NIOSH
- This N95 dust mask can be used for woodworking or painting at home or by professional carpenters, contractors, or lawn care specialists.
- Adjustable head strap and metal nose bridge with full foam flange eliminates pressure points with added comfort
- Exhalation valve reduces moist gathered during breath, providing high breathing comfort

All-IN-ONE Filtration System for Common Harmful Particle



Paint



Woodworking



Construction



Welding



Cutting



Mowing

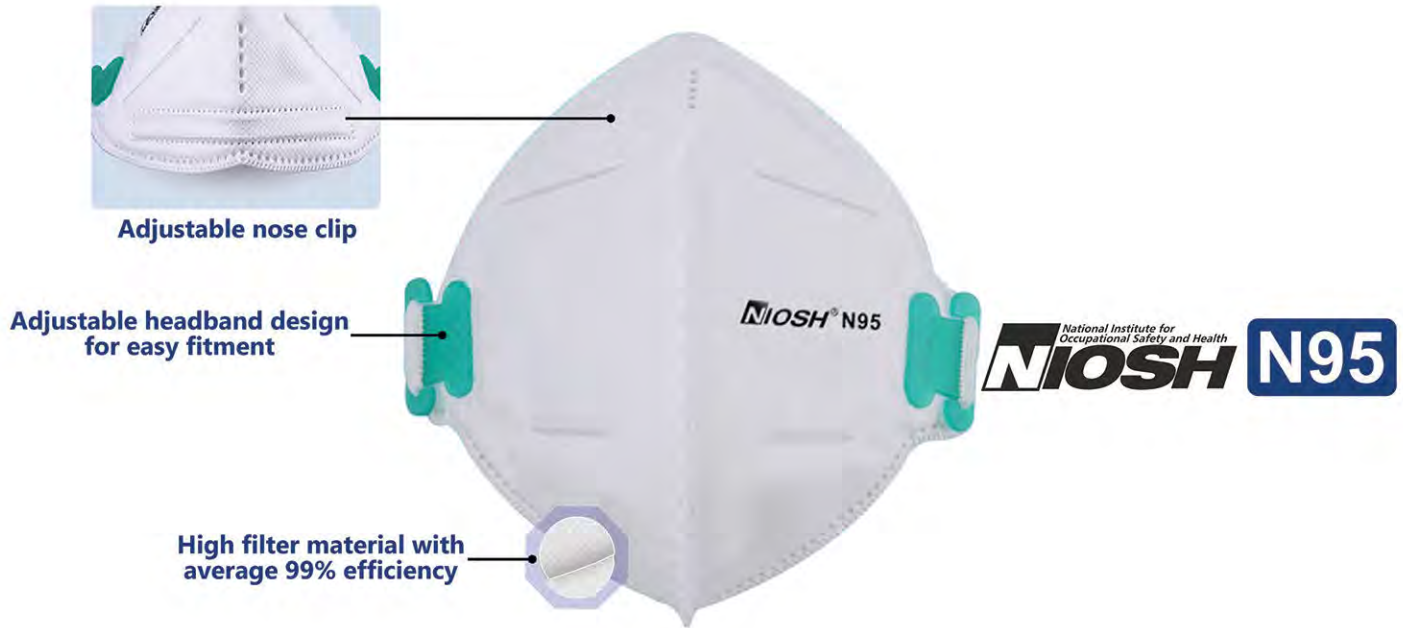

40355

Foldable Disposable N95 Mask / Particulate Respirator – NIOSH CERTIFIED (20/BOX)

Features:

- NIOSH approved for at least 95 percent filtration efficiency against certain non-oil based particles
- Cushioning nose foam
- Lightweight construction promotes greater worker acceptance and may help increase wear time
- This N95 dust mask can be used for woodworking or painting at home or by professional carpenters, contractors, or lawn care specialists.
- Special filter material is designed for ease of breathing
- Protects respiratory system while grinding, sanding, or bagging
- Not recommended for asbestos or sandblasting protection

Note: Breathing hazardous particles can pose a risk to your health. NIOSH, a Federal government regulatory agency, has tested and approved the INTERSTATE SAFETY Particulate Respirator, which is designed to help reduce exposure to certain airborne particles.

All-IN-ONE Filtration System for Common Harmful Particle



Haze



Woodworking



Construction



Fire Smoke



Cutting



Mowing

FOLDABLE DISPOSABLE KN95 MASK / PARTICULATE RESPIRATOR

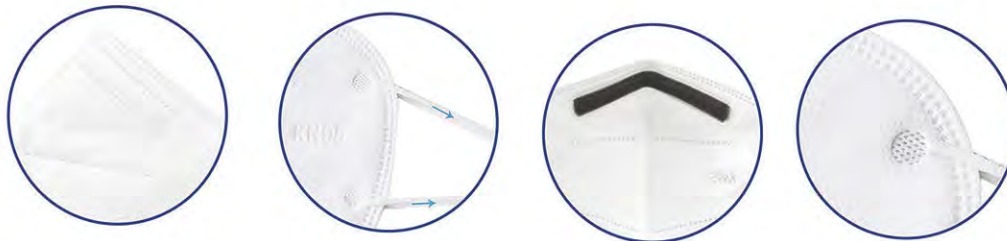
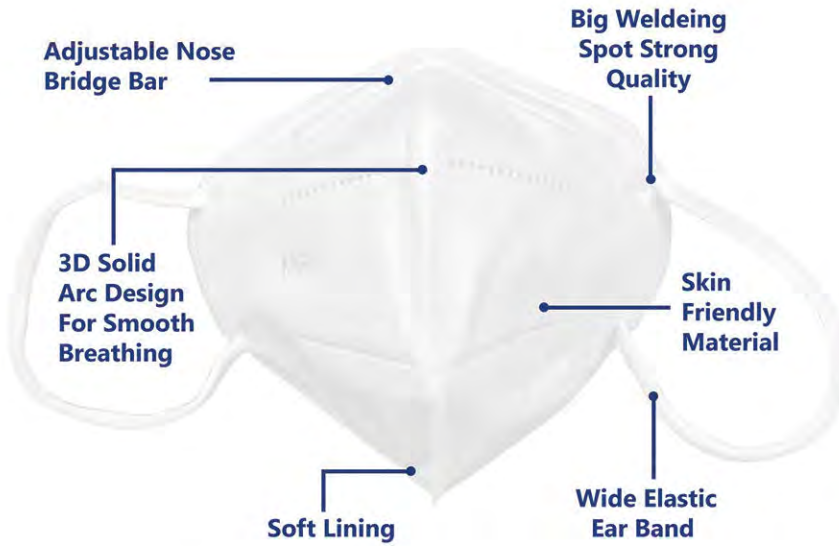

40365 (3/Bag)

40365-BX (20/Box)

Foldable Disposable KN95 Mask / Particulate Respirator – (3/BAG)

Features:

- This product is NOT included on the FDA Emergency Use Authorization List. The CDC tested limited number of masks from this manufacturer and found that the filtration efficiency was above 95%. See the CDC website for a copy of the testing report.
- **BETTER PROTECTION:** 5 Layer Face Protection Filtration >95% Safety Masks is designed to offer more protection than standard disposable 3-Ply masks.
- **LIGHTWEIGHT and FOLDABLE:** The vertical folding design and overall lightweight structure make this mask easy to store and carry.
- **SMOOTH BREATHING:** Flexible metal fastening strip ensures optimal sealing between the bridge of the nose and the mask.

All-IN-ONE Filtration System for Common Harmful Particle



Haze



Woodworking



Construction



Fire Smoke



Cutting



Mowing

DISPOSABLE FACE MASKS WITH ELASTIC EARLOOP

40353 - 25 Pcs/Box

40354 - 50 Pcs/Box

40364 - 16 Bags of 3 Masks/Bag (Total 48 Masks)

Features:

- Protect against large-particle droplets, splashes, sprays, saliva that may contain germs (viruses & bacteria)
- Great for filter out dust, smoke & pollen
- Soft, odorless & non-irritating - 3 Layer Protection



REUSABLE 100% COTTON FACE MASK WITH EARLOOP

40356 - White Color

40357 - Black Color

40358 - Maroon Color

40359 - Green Color

40360 - Assorted Kit (White,Black,Green)

40361 - Assorted Kit (White,Black,Maroon)

40362 - 3 Pack - White

40363 - 3 Pack - Black



Features:

- The mask is made of cotton to keep your face soft and comfortable
- One size fits most adults. With elastic ear loops for close fit, easy to wear and take off
- Machine washable, breathable, and reusable

HARD HATS / EARMUFFS

40401 - Yellow Color

40411 - White Color

Front Brim Hard Hat / Safety Helmet, Snap Lock 6 Point Ratchet Suspension with Cap-Mount Ear Muff Slots - 6-1/2" to 8" Headband Size - Yellow Color

Features:

- ANSI compliant when worn in the forward and reverse positions
- Low profile hard hat for improved stability & balance
- Comfortable suspension sits lower on head to reduce pressure points and increase security
- Lightweight protection and durability for extended comfort
- Quick ratchet adjustment system with 6-point suspension
- High density polyethylene construction

Specification:

- Type 1, Class E, G, and C
- Headband sizes: 6-1/2"– 8"
- Material: HDPE
- ANSI: Z89.1 - 2014



ANSI: Z89.1 - 2014



6-Point Impact Absorbing Suspension for Added Safety



Easy Knob Adjustment

40402 - White Color

40408 - Yellow Color

40409 - Blue Color

40410 - Red Color

Full Brim Hard Hat / Safety Helmet, Snap Lock 4 Point Ratchet Suspension - 6-1/2" to 8" Headband Size

Features:

- Lightweight, yet rugged high-density polyethylene construction provides excellent protection & comfortable wear
- Comfortable, 4-point suspension with vertical height adjustment assures a personal, secure fit
- Comfortable suspension sits lower on head to reduce pressure points and increase security
- Ratchet suspension adjusts size quickly and easily
- Full brim design offers added protection against rain, sun, and snow

Specification:

- Type 1, Class E, G, and C
- Headband sizes: 6-1/2"– 8"
- Material: HDPE
- ANSI: Z89.1 - 2014



ANSI: Z89.1 - 2014

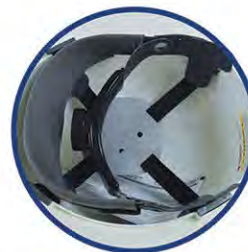

4-Point Impact Absorbing Suspension for Added Safety



Easy Knob Adjustment

HARD HATS / EARMUFFS / RACHET SUSPENSIONS

40403

Sweatband for Hard Hat / Safety Helmet

Features:

- Instantly Absorbs/Wicks Sweat Away: Keeps sweat out of your eyes, safety glasses & goggles or protective eyewear
- Sweat Stain Prevention: Helps prevent NASTY Sweat Stains on your headwear.
- Comfortable: Thin, soft, and lightweight
- Hypoallergenic: Helps prevent acne & skin irritation



Specially used with our hard hats
Models 40401,40402,40408,40409,40410,40411

40404

4 Point Ratchet Suspension for Hard Hat / Safety Helmet

40405

6 Point Ratchet Suspension for Hard Hat / Safety Helmet

Features:

- Comfortable Impact-Absorbing 4 & 6 Point Woven Nylon Suspension
- Smooth ratchet rotation and secure hold
- Ratchet comfort pad contours to the back of the head to improve airflow and prevent hair-pulling
- Adjusts to Head sizes 6.5" to size 8"
- Easy Knob adjustment



Specially used with our hard hats
Models 40401,40402,40408,40409,40410,40411

40406

Cap Mounted / Hard Hat Attachable Earmuff

29 dB NRR - ANSI S 3.19

Features:

- Attaches comfortably and easily fits most slotted hardhats
- Stainless steel band construction resists bending and warping to offer consistent pressure over prolonged wearing periods
- Earcup pivot points title for optimum comfort and efficiency
- Bread foam cushions provide low surface pressure
- NRR independently tested to ANSI S 3.19 / CE EN352-3 for protection you can count on
- NRR 29 dB

Recommended industries: Aviation, farming, construction, lumber, steel, transportation, military, law enforcement, manufacturing, sporting, DIY projects, general contracting.



29 dB NRR - ANSI S 3.19



Can also be used with our
hard hat Models 40401, 40411

40407

4-Points Adjustable Chin Straps for Hard Hats

Features:

- Non-metal chin strap keeps helmets in place
- Flexible construction and adjustable design for long wearing comfort
- For use with Interstate Safety Helmets



40412

Neck Shield / Shade
High Visibility LIME Color
with Reflective Tape

40413

Neck Shield / Shade
High Visibility ORANGE Color
with Reflective Tape



Features:

- Attaches to the brim of Safety Helmets/Hard Hats.
- Shields neck from sun and heat - prevents sun burn
- Reflective, high visibility, ultra light weight.
- Elastic Band keeps neck shield secured to helmet

40253

40253-12PK (12/Pack)
Safety Face Shield, Lightweight
Transparent Shield with Stretchy
Elastic Band

Features:

- High-density polyethylene casing, which prevents chemicals, saliva droplets, and paints from splashing into the eyes. This protects your eyes and face well.
- Safe and comfortable, the full face protective cap provides more comprehensive coverage and protects the face from saliva flying into the air.
- Face / shield visor can be easily cleaned with water or disinfectant. Ultimate sun protection, scratch resistance, blocking more than 98% of harmful air.
- Plastic face - shield fully adjustable head harness that moves up and down easily and fits comfortably with most goggles and respirators.
- Extremely light and can be used in various situations, such as laboratory work, woodworking, mowing, gardening, drilling, sanding, welding, outdoor sports, etc.



BACK SUPPORT BELTS



Economy Double Pull Elastic Back Support Belt with Adjustable Shoulder Straps

Size Chart:

- **40150-S:** 30" ~ 36" (Waist Circumference)
- **40150-M:** 36" ~ 40" (Waist Circumference)
- **40150-L:** 38" ~ 47" (Waist Circumference)
- **40150-XL:** 46" ~ 56" (Waist Circumference)

Use one of these ("-S", "-M", "-L", "-XL") letter designation for the waist size when you order

Features:

- High quality back support belt; Used for work, sports & everyday activities to provide support & reduce unwanted twisting of the spine
- Protects the spine from injury and unnecessary stress
- The mesh micropores ensure air penetration, with heat and sweat dissipation
- Removable knit suspenders enhance comfort during use minimizing strain on the groin area. Ideal for daily use during work
- Prevents chronic back pain, treats lumbar strains, muscle strains, pain from over use and develop better back posture for sitting and working. Specifically designed for industrial use

Applications:

The lumbar support back brace is great for:

- People who are involved in heavy work like lifting weight.
- People who are always sitting in front of the computer or doing the daily chores.
- Older people who need support or feel painful on their back or waist

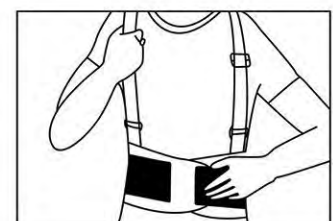
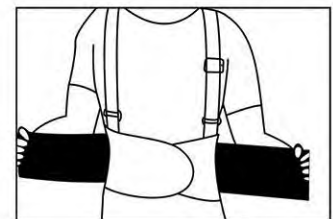
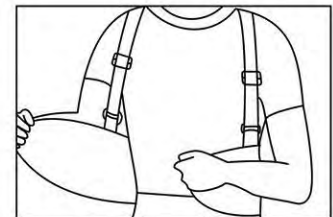
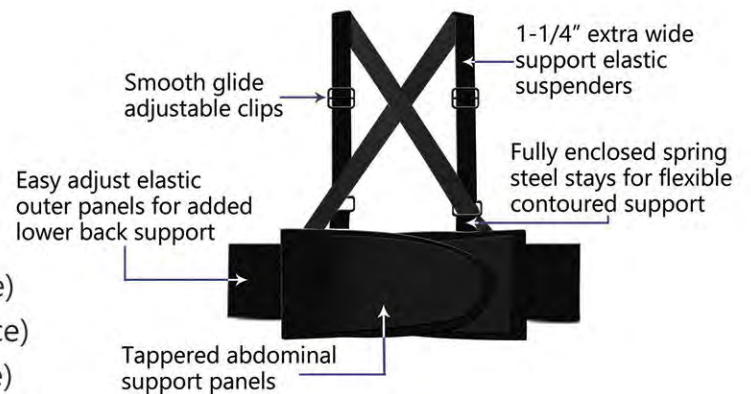



6" Nylon Back Support Belt

Size Chart:

- **40152-M:** 34" ~ 40" (Waist Circumference)
- **40152-L:** 36" ~ 42" (Waist Circumference)
- **40152-XL:** 38" ~ 44" (Waist Circumference)

Use one of these ("-M", "-L", "-XL") letter designation for the waist size when you order

Features:

- Nylon Material & Nylon thread stitching for durability and longevity
- Features heavy gauge plastic buckle for customized fit
- Allows for custom fit and adjustable compression to abdomen and lower back, especially when the back-brace material starts loosening
- The back-support belts suitable for multiple activities like Running, Climbing, Car driving, Jogging etc.
- Provides safe protection for the waist. Commonly used by people suffering from back pain, lower back and lumbar pain, sciatica, tendonitis, stiff or sore muscles

3.5 MIL WHITE POWDER-FREE LATEX DISPOSABLE GLOVES

Part# 40300 (M Size)

Part# 40301 (L Size)

Part# 40302 (XL Size)

3.5 MIL | **100 PCS**
DISPOSABLE GLOVES | **POWDER**
FREE

Features:

- Latex for Extreme comfort, Non-Sterile Durability, Powder-free, Hypoallergenic
- Superior Strength, Puncture Resistant, Ambidextrous gloves, maintaining Tactile Feel
- Great for Cleaning around the house. Law Enforcement, Maintenance and Cleanup
- Micro-textured for maximizing gripping power; Textured finger tips for great gripping strength for wet or dry applications
- Extra protection, Better Puncture Resistance than latex or vinyl, Smooth interior finish for easy donning

Ideal Use With:

- Cleaning
- Labwork
- Hair Coloring
- Painting
- Pet Care
- Arts & Crafts



5 MIL BLACK POWDER-FREE NITRILE DISPOSABLE GLOVES



Part# 40310 (M Size)

Part# 40311 (L Size)

Part# 40312 (XL Size)

5 MIL

**100 PCS
DISPOSABLE GLOVES**

**POWDER
FREE**



Features:

- Nitrile for Extreme comfort, Non-Sterile Durability, Powder-free, Hypoallergenic
- Superior Strength, Puncture Resistant, Ambidextrous gloves, maintaining Tactile Feel
- Great for Industrial use, Maintenance, Plumbing Industries, gardening, machine shop, food and beverage use.
- Micro-textured for maximizing gripping power; Textured finger tips for great gripping strength for wet or dry applications
- Extra protection, Better Puncture Resistance than latex or vinyl, Smooth interior finish for easy donning



Beaded Cuff



Latex Free



Textured
FingerTips



Tactile
Sensitivity



Puncture
Resistant



Ideal Use With:

- Cleaning
- Labwork
- Hair Coloring
- Painting
- Pet Care
- Arts & Crafts



MECHANICAL WORK



CLEANING



PLUMBING



COOKING

40450-L

Size: Large

40451-XL

Size: Extra Large

Features:

- All seam welded PVC laminated on polyester fiber
- Stand-up collar with snap button detachable hood with strings
- Raglan sleeve design with snap buttons on cuff
- Venilated cape back and underarm
- Five snap button front closure with storm flap
- Side pockets with snap button closure (2)





**INTERSTATE
SAFETY**



A Subsidiary of American General Tool Group

929 Poinsettia Avenue, Suite 101 Vista, CA 92081

www.interstatesafetygear.com

